



McIntosh Laboratory, Inc. 2 Chambers Street Binghamton, New York 13903-2699 Phone: 607-723-3512 www.mcintoshlabs.com

MCT500
SACD/CD Transport
Owner's Manual



The lightning flash with arrowhead, within an equilateral triangle, is intended to alert the user to the presence of uninsulated “dangerous voltage” within the product’s enclosure that may be of sufficient magnitude to constitute a risk of electric shock to persons.

WARNING - TO REDUCE RISK OF FIRE OR ELECTRICAL SHOCK, DO NOT EXPOSE THIS EQUIPMENT TO RAIN OR MOISTURE.

Additional Safety Information is supplied in a separate document “Important Additional Operation Information Guide”



ATTENTION:
RISQUE DE CHOC ELECTRIQUE - NE PAS OUVRIR

NO USER-SERVICEABLE PARTS INSIDE. REFER SERVICING TO QUALIFIED PERSONNEL.

The exclamation point within an equilateral triangle is intended to alert the user to the presence of important operating and maintenance (servicing) instructions in the literature accompanying the appliance.

To prevent the risk of electric shock, do not remove cover or back. No user-serviceable parts inside.

CAUTION: Invisible Laser Radiation when open. **DO NOT** stare into the beam or view directly with optical instruments. Use of controls or adjustments or performance of procedures other than those specified in the Owners Manual may result in Hazardous Radiation Exposure.

ATTENTION: Rayonnement Laser Invisible en cas d’ouverture. Ne pas regarder dans le faisceau ni observer directement à l’aide d’instruments d’optiques. L’utilisation de commandes, de réglages ou d’instructions autres que ceux spécifiés dans le manuel du propriétaire peut entraîner une exposition x à des rayonnements dangereux

This product incorporates an embedded **CLASS 3R Laser (IEC60825-1).**

**LUOKAN 1 LASERLAITE
KLASS 1 LASER APPARAT**

VAROITUS! Laitteen käyttäminen muulla kuin tassa käyttöohjeessa mainitulla tavalla saattaa altistaa käyttäjän turvallisuusluokan 1 ylittävälle näkymättömälle lasersäteilylle.

VARNING! Om apparaten används på annat sätt än i denna bruksanvisning specificerats, kan användaren utsättas för osynlig laserstrålning, som överskrider gränsen för laserklass 1.

CAUTION: CLASS 3R INVISIBLE LASER RADIATION WHEN OPEN. DO NOT STARE INTO THE BEAM OR VIEW DIRECTLY WITH OPTICAL INSTRUMENTS. AVOID DIRECT EYE EXPOSURE.
ATTENTION: RAYONNEMENT LASER INVISIBLE DE CLASSE 3R EN CAS D’OUVERTURE. NE PAS REGARDER DANS LE FAISCEAU NI OBSERVER DIRECTEMENT À L’AIDE D’INSTRUMENTS D’OPTIQUE. EXPOSITION DIRECTE DANGEREUSE DES YEUX.

**CLASS 1
LASER PRODUCT**

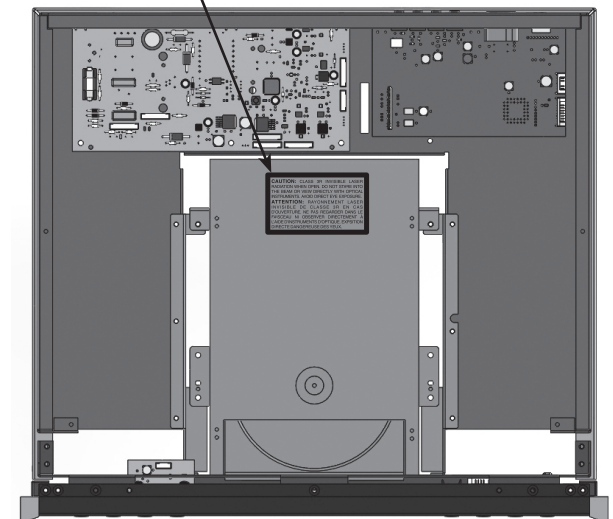

Thank You

Your decision to own this McIntosh MCT500 SACD/CD Transport ranks you at the very top among discriminating music listeners. You now have “The Best.” The McIntosh dedication to “Quality,” is assurance that you will receive many years of visual and musical enjoyment from this unit.

Please take a short time to read the information in this manual. We want you to be as familiar as possible with all the features and functions of your new McIntosh.

Please Take A Moment

The serial number, purchase date and McIntosh Dealer name are important to you for possible insurance claim or future service. The spaces below have been provided for you to record that information:

Serial Number: _____

Purchase Date: _____

Dealer Name: _____

Technical Assistance

If at any time you have questions about your McIntosh product, contact your McIntosh Dealer who is familiar with your McIntosh equipment and any other brands that may be part of your system. If you or your Dealer wish additional help concerning a suspected problem, you can receive technical assistance for all McIntosh products at:

McIntosh Laboratory, Inc.
2 Chambers Street
Binghamton, New York 13903
Phone: 607-723-1545
Fax: 607-724-0549

Customer Service

If it is determined that your McIntosh product is in need of repair, you can return it to your Dealer. You can also return it to the McIntosh Laboratory Service Department. For assistance on factory repair return procedure, contact the McIntosh Service Department at:

McIntosh Laboratory, Inc.
2 Chambers Street
Binghamton, New York 13903
Phone: 607-723-3515
Fax: 607-723-1917

Table of Contents

Safety Instructions	2
(Separate Sheet)	Important Additional
	Operation Information Guide
Thank You and Please Take a Moment.....	3
Technical Assistance and Customer Service	3
Table of Contents	3
General Information	4
Connector and Cable Information	4
Disc Information.....	4-5
Introduction.....	5
Performance Features	5
Dimensions	6
Installation	7

Connections:

Rear Panel Connections	8
Connections using to Analog Preamplifier and Integrated Amplifier	10
Connection Diagrams (Separate Sheet).....	MclA
Connections using to Digital Preamplifier	11
Connection Diagram (Separate Sheet).....	MclB

Front Panel Features:

Front Panel Display, USB Connector and Push-buttons.....	12
Front Panel Information Display.....	13

Remote Control:

Remote Control Push-buttons for CD Disc and SACD Disc Playback	14
How to Use the Remote Control for CD Disc and SACD Disc Playback	15
Remote Control Push-buttons for Playback of Data CD, Data DVD Disc and USB Flash Memory Data Drive	16
How to Use the Remote Control for Playback of Data CD, Data DVD Disc and USB Flash Memory Data Drive.....	17

Operation:

How to Operate the MCT500	18-24
---------------------------------	-------

Additional Information:

Photos.....	25
Specifications.....	26
Packing Instruction.....	27



General Information

1. For additional connection information, refer to the owner's manual(s) for any component(s) connected to the MCT500 SACD/CD Transport.
2. The Super Audio Compact Discs Audio Signals are available at the MCT Digital Audio Output Connector. Compact Discs Audio Signals are available at the Digital Audio Output XRL, Optical, Coaxial and MCT Connectors.
3. The IR Input, with a 3.5mm mini phone jack, is configured for non-McIntosh IR sensors such as a Xantech Model HL85BK Kit. Use a Connection Block such as a Xantech Model ZC21 when two or more IR sensors need to be connected to the MCT500.
4. When discarding the unit, comply with local rules or regulations. Batteries should never be thrown away or incinerated but disposed of in accordance with the local regulations concerning battery disposal.
5. For additional information on the MCT500 and other McIntosh Products please visit the McIntosh Web Site at www.mcintoshlabs.com.



Connector and Cable Information

XLR Connectors (Digital Audio)

Below is the Pin configuration for the XLR Balanced Digital Audio Connectors on the MCT500. Refer to the diagram for connection:

- PIN 1: Shield/Ground
- PIN 2: + Signal
- PIN 3: - Signal

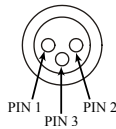

Note: When connecting to the MCT500 Digital XLR Input and Output connectors it is important to use a twisted pair shielded cable.

Data and IR Input Port Connectors

The MCT500 Data In Port receives Remote Control Signals. A 3.5mm stereo mini phone plug is used for connection. The IR Ports also use a 3.5mm stereo mini phone plug and allow the connection of other brand IR Receivers to the MCT500.

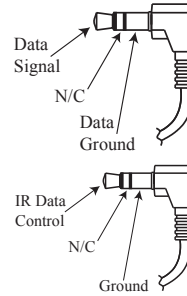

Power Control Connector

The MCT500 Power Control Input receives an On/Off signal from (+12 volt/0 volt). The Power Control Output will then send out a +12 volt Output Signal with a total current up to 50mA. An additional connection is for controlling the illumination of the Power Output Meters. The 3.5mm stereo mini phone plug connects to a McIntosh Preamplifier or A/V Control Center Power Control Output.

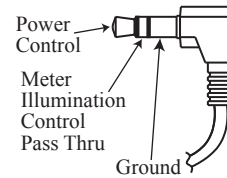

Digital MCT Cable

The Digital MCT Cable supplied with the MCT500 is a McIntosh Designed Custom Cable. A substitute cable will not work with the MCT500 and McIntosh Preamplifiers with a Digital MCT Connector. If it should become necessary to replace the supplied Digital MCT cable, order part number 171923 from the McIntosh Parts Department.



Disc Information

1. The MCT500 is designed to play round Compact Discs; do not try other shapes or possible damage may occur.
2. The MCT500 SACD/CD Transport is designed to play all industry standard "Redbook" CD Audio Discs as indicated by the  Symbol. It will also play most CD-R, CD-RW and Dual Discs, however some recorded discs may not be able to play due to the condition of the recording or manufacturing.
3. Disc with tracks recorded with MP3 and WMA Formats will playback on the MCT500 when the writing software used to create them conforms to the ISO9660 Level 1 standard.
4. The PCM (Pulse Code Modulation) Digital Signal, is the standard for Audio CD Discs and is available at all Digital Audio Output Connectors on the MCT500. Discs with WAV and MP3 file formats are converted internally to a PCM Digital Signal.
5. Playing back Audio from a CD Disc and a SACD Disc (CD Layer) is available at the MCT, Optical and Coaxial Digital Outputs. When a SACD Disc is playing back a 2 Channel Layer, the Digital Audio is only available at the MCT Digital Audio Output, with the Optical and Coaxial Outputs muted. (The Multichannel Layer will be silent because the MCT500 is a stereo unit.)
6. The MCT500 has the ability to playback a user created DVD Data Disc. When a disc has Audio Tracks up to DSD128 and PCM up to 96Khz/24Bit, the Digital Audio Signal is available at the MCT Digital Audio Output. PCM Audio Tracks up to 192kHz-24Bit are available at the XLR Optical and Coaxial Digital Outputs.

Media and Format Type of Music Playback			
Media Type	Format Type and File Extension	Maximum Sampling Frequency	Maximum Bit Rate
CD Disc (R/-RW)	MP3 (.mp3)	48KHz	Up to 320kbs
CD Disc (R/-RW)	WMA (.wma)	48KHz	Up to 320kbs
CD Disc (R/-RW)	ACC (.mp4)	48KHz	Up to 320kbs
CD Disc (R/-RW+R+RW)	WAV (.wma)	48KHz	16Bit
CD Disc (R/-RW+R+RW)	FLAC (.flac)	48KHz	16Bit
CD Disc (R/-RW+R+RW)	ALAC (.m4a)	48KHz	16Bit
CD Disc (R/-RW+R+RW)	AIFF(.aif/aiff)	48KHz	16Bit
DVD Disc (R/-RW+R+RW)	WAV (.wma)	192KHz	Up to 24Bit
DVD Disc (R/-RW+R+RW)	FLAC (.flac)	192KHz	Up to 24Bit
DVD Disc (R/-RW+R+RW)	ALAC (.m4a)	192KHz	Up to 24Bit
DVD Disc (R/-RW+R+RW)	AIFF(.aif/aiff)	192KHz	Up to 24Bit
DSD Disc (DSD64 to DSD128)	DSD(.diff/dsf)	5.6MHz	1Bit
USB Flash Drive supports all the Disc Media Types, Format Types and File Extensions. It also has the same Maximum Sampling Frequencies and Bit Rates.			

Introduction

The McIntosh MCT500 SACD/CD Transport offers the latest in audio technology, providing state of the art reproduction of audio discs. A full complement of performance features allows for the enjoyment of the SACD and CD Disc Audio Formats. The advanced mechanical design of the transport ensures many years of smooth trouble free operation.

Performance Features

- **Twin Laser Pickup**

The MCT500 incorporates two laser elements, with different wavelengths, that are focused through one lens assembly. This unique design allows reading both the CD and Super Audio Compact Disc (SACD) Discs Formats.

- **Advanced Transport**

The MCT500 has a new transport with a Die Cast Tray. It has the latest in advanced digital servo for faster, quieter and accurate operation. The Disc Audio Data is read at twice the normal rate insuring better disc tracking and error correction processing.

- **USB Music Playback**

The Front Panel USB Connector is for a USB Flash Memory Drive. This provides the ability to Playback all of the Disc Media Types at the Maximum Sampling Frequencies and the Highest Bit Rates available.

- **Advanced Digital MCT Output**

A unique Digital MCT Output connects to McIntosh Preamplifiers with a Digital MCT Connector for the purest possible sound quality.

- **Digital Audio Outputs**

The MCT500 Digital Outputs include XRL, Coaxial, Optical and MCT Connections.

- **Power Control and Full Function Remote Control**

The Power Control Input Connection switches the MCT500 On/Off with other McIntosh Components in a system. The Remote Control provides complete control of the MCT500 operating functions.

- **Multi-Function Front Panel Display**

The MCT500 Front Panel display indicates the current disc playback status.

- **Special Power Supply**

Switching Power Supply with Multiple Regulators to ensure stable noise free operation even though the power line varies.

- **Glass Front Panel and Super Mirror Chassis**

The MCT500 has the famous McIntosh Illuminated Glass Front Panel and Stainless Steel Super Mirror Finish Chassis. These highly durable materials will ensure the pristine beauty of the MCT500 will be retained for many years.

- **LED Front Panel Illumination**

The Illumination of the Front Panel is accomplished by Light Diffusers and extra long life Light Emitting Diodes (LEDs). This provides even Front Panel Illumination and is designed to ensure the pristine beauty of the MCT500 will be retained for many years.



Dimensions

The following dimensions can assist in determining the best location for your MCT500.

Front View of the MCT500

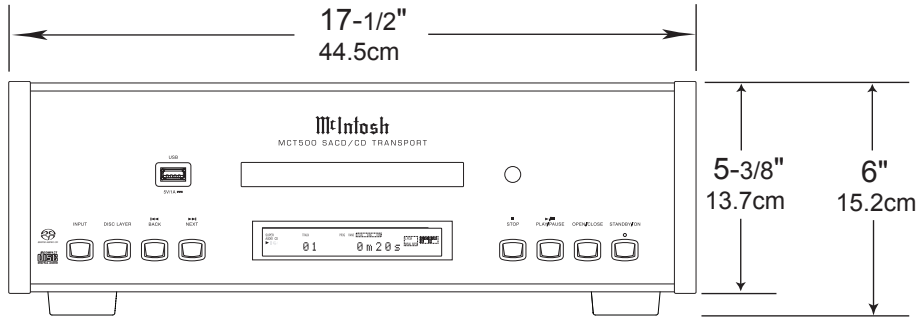

Rear View of the MCT500

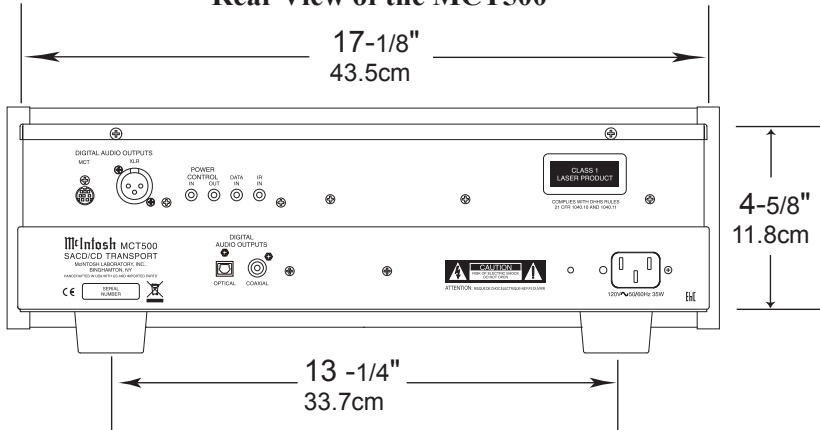

Side View of the MCT500

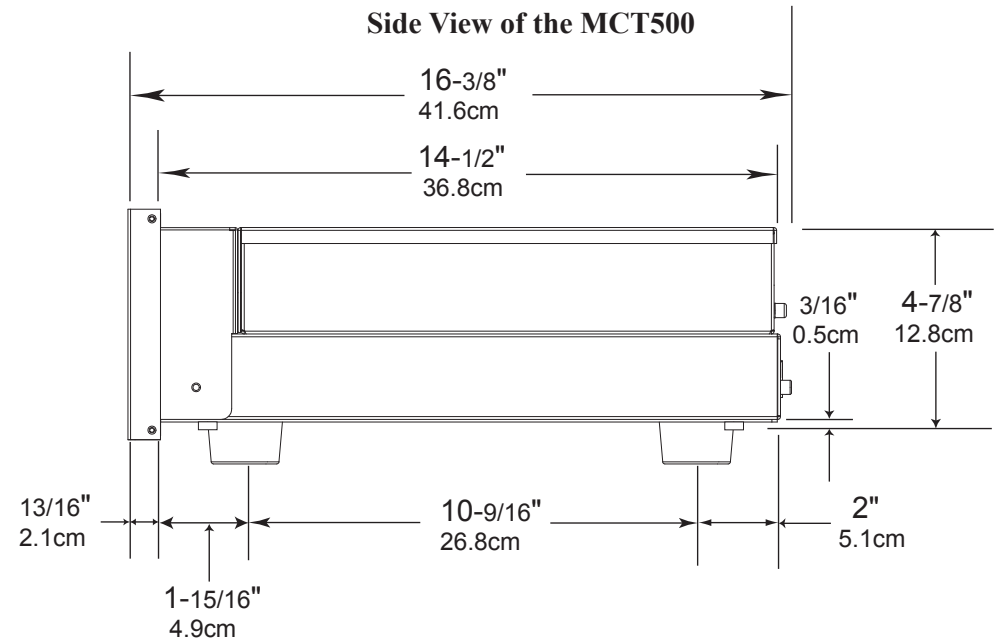

Installation

The MCT500 can be placed upright on a table or shelf, standing on its four feet. It also can be custom installed in a piece of furniture or cabinet of your choice. The four feet may be removed from the bottom of the MCT500 when it is custom installed as outlined below. The four feet together with the mounting screws should be retained for possible future use if the MCT500 is removed from the custom installation and used free standing. The required panel cutout, ventilation cutout and unit dimensions are shown.

Always provide adequate ventilation for your MCT500. Cool operation ensures the longest possible operating life for any electronic instrument. Do not install the MCT500 directly above a heat generating component such as a high powered amplifier. If all the components are installed in a single cabinet, a quiet running ventilation fan can be a definite asset in maintaining all the system components at the coolest possible operating temperature.

A custom cabinet installation should provide the following minimum spacing dimensions for cool operation.

Allow at least 2 inches (5.1cm) above the top, 2 inches (5.1cm) below the bottom and 1 inch (2.5cm) on each side of the SACD/CD Transport, so that airflow is not obstructed. Allow 17 inches (43.2cm) depth behind the front panel. Allow 1-1/8 inch (2.9cm) in front of the mounting panel for knob clearance. Be sure to cut out a ventilation hole in the mounting shelf according to the dimensions in the drawing.

MCT500 Front Panel Custom Cabinet Cutout

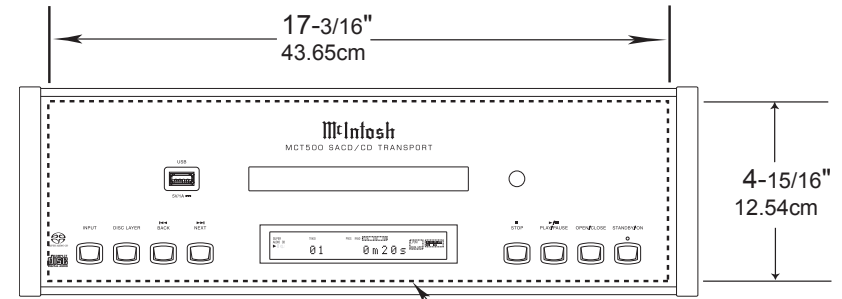

Cutout Opening for Custom Mounting

MCT500 Side View in Custom Cabinet

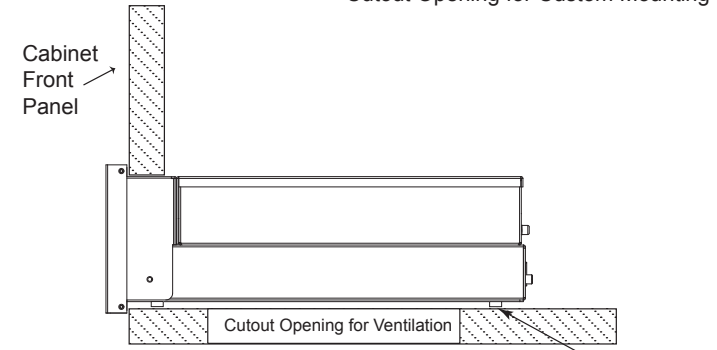

MCT500 Bottom View in Custom Cabinet

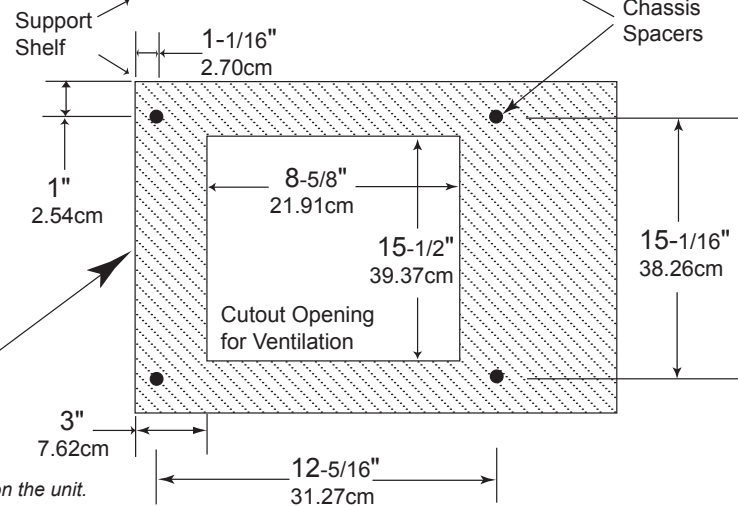

Note: Center the cutout horizontally on the unit.
For purposes of clarity, the above illustration is not drawn to scale.



XLR DIGITAL AUDIO OUTPUT sends a PCM Digital Signal to a Preamplifier with internal D/A Converter to decode the signal into analog audio

DATA IN receives control data from a McIntosh Control Center

POWER CONTROL IN receives turn-on signals from a McIntosh component and POWER CONTROL OUT sends turn-on signals on to another McIntosh Component

Connect the MCT500 power cord to a live AC outlet. Refer to information on the back panel of your MCT500 to determine the correct voltage for your unit

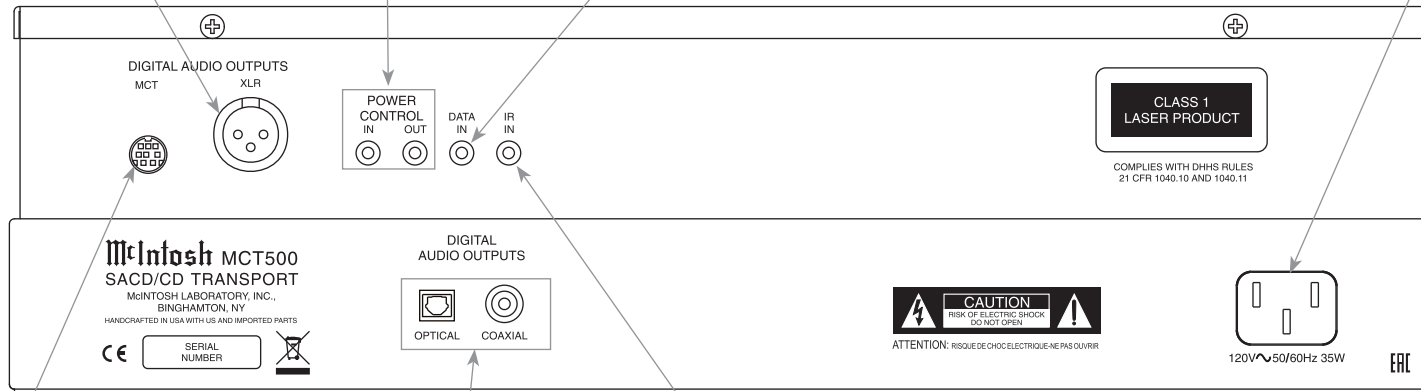

MCT DIGITAL AUDIO OUTPUT sends PCM or SACD Digital Signal to a Preamplifier with internal D/A Converter to decode the signal into analog audio

OPTICAL and COAXIAL DIGITAL AUDIO OUTPUTS send a PCM Digital Audio Signal to a Preamplifier or an A/V Control Center to decode the signal into analog audio

IR IN for connecting an IR Receiver

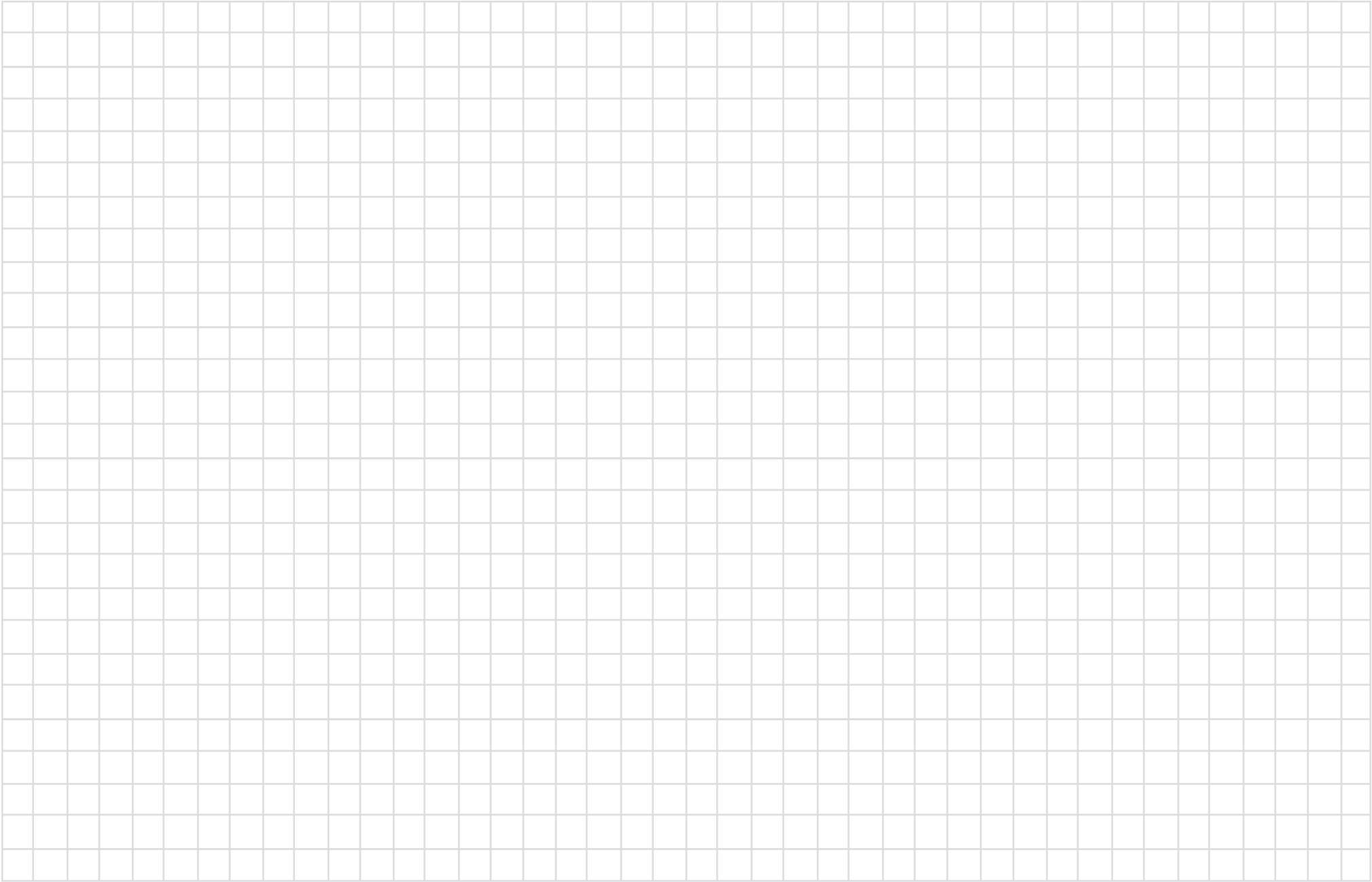



Connections to Analog Preamplifier and Integrated Amplifier

The MCT500 Digital Audio MCT Output Connector outputs PCM and SACD Digital Disc Signals when connected to a compatible McIntosh Preamplifier or Integrated Amplifier. Power Control provides the ability to be remotely switched On/Off from a Preamplifier or Integrated Amplifier via the PWR CTRL (Power Control) Connection.

The MCT500 Data Port Connection allows for the remote operation of basic functions using the Preamplifier or Integrated Amplifier Remote Control. With an external sensor connected to the MCT500, remote control operation is possible from another room and/or when the MCT500 is located in a cabinet with the doors closed.

The connection instructions below, together with the MCT500 Connection Diagram located on the separate folded sheet “Mc1A” is an example of a typical audio system. Your system may vary from this, however the actual components would be connected in a similar manner. For additional information refer to “Connector and Cable Information” on page 4.

Power Control Connections:

1. Connect a Control Cable from the Preamplifier or Integrated Amplifier Power Control Main Out Jack to the POWER CONTROL IN Jack on the McIntosh MCT500 SACD/CD Transport.
2. Optionally, connect a Control Cable from the MCT500 SACD/CD Transport POWER CONTROL OUT Jack to additional McIntosh components with a Power Control In Jack.

Data Control Connections:

3. When a Data Port connection on the Preamplifier or Integrated Amplifier is available, connect a Control Cable from the Preamplifier or Integrated Amplifier (Setup Assigned) Data Port Jack to the

McIntosh MCT500 SACD/CD Transport DATA IN Jack.

Sensor Connections:

4. Optionally, connect an IR Sensor to the McIntosh MCT500 SACD/CD Transport IR IN Jack.

Digital Audio Connections:

5. Connect the supplied Digital MCT Cable from the McIntosh MCT500 SACD/CD Transport DIGITAL AUDIO OUTPUT MCT connector to the Digital MCT Audio Input Connector on the Preamplifier or Integrated Amplifier.

Notes: 1. For playback of SACD Discs, the Digital MCT Output Connection between the MCT500 and Digital MCT Audio Input on a Preamplifier or Integrated Amplifier is required.

2. When playing back high resolution DVD Data or CD Data Disc PCM recording with a sampling rate higher than 92kHz/24Bit, the Optical or Coaxial connection between the MCT500 and Preamplifier or Integrated Amplifier will be required for listening.

6. Connect a fiber Optical Cable from the MCT500 SACD/CD Transport DIGITAL AUDIO OUTPUT OPTICAL Connector to the Optical Digital Input 1 on the Preamplifier or Integrated Amplifier.

Note: A Coaxial Cable Connection may be used instead of the Optical Connection.

AC Power Cords Connections:

7. Connect the McIntosh MCT500 SACD/CD Transport AC Power Cord to a live AC outlet.



Connections to Digital Preampifier

The MCT500 Digital Audio MCT Output Connector outputs PCM and SACD Digital Disc Signals when connected to a compatible McIntosh Digital Preampifier. Power Control provides the ability to be remotely switched On/Off from the Digital Preampifier via the PWR CTRL (Power Control) Connection.

The MCT500 Data Port Connection allows for the remote operation of basic functions using the Digital Preampifier Remote Control. With an external sensor connected to the MCT500, remote control operation is possible from another room and/or when the MCT500 is located in a cabinet with the doors closed.

The connection instructions below, together with the MCT500 Connection Diagram located on the separate folded sheet “**Mc1B**” is an example of a typical audio system. Your system may vary from this, however the actual components would be connected in a similar manner. For additional information refer to “Connector and Cable Information” on page 4.

Power Control Connections:

1. Connect a Control Cable from the Digital Preampifier Power Control Main Out Jack to the POWER CONTROL IN Jack on the McIntosh MCT500 SACD/CD Transport.
2. Optionally, connect a Control Cable from the MCT500 SACD/CD Transport POWER CONTROL OUT Jack to additional McIntosh components with a Power Control In Jack.

Data Control Connections:

3. When a Data Port connection on the Digital Preampifier is available, connect a Control Cable from the Digital Preampifier (Setup Assigned) Data Port Jack to the McIntosh MCT500 SACD/CD Transport DATA IN Jack.

Sensor Connections:

4. Optionally, connect an IR Sensor to the McIntosh MCT500 SACD/CD Transport IR IN Jack.

Digital Audio Connections:

5. Connect the supplied Digital MCT Cable from the McIntosh MCT500 SACD/CD Transport DIGITAL AUDIO OUTPUT MCT connector to the Digital MCT Audio Input Connector on the Digital Preampifier.

Notes: 1. For playback of SACD Discs, the Digital MCT Output Connection between the MCT500 and Digital MCT Audio Input on the Digital Preampifier is required.

2. *When playing back high resolution DVD Data or CD Data Disc PCM recording with a sampling rate higher than 92kHz/24Bit, the Digital XLR Connection between the MCT500 and Digital Preampifier will be required for listening.*

6. Connect a XLR Cable from the MCT500 SACD/CD Transport DIGITAL XLR AUDIO OUTPUT Connector to the Digital XLR Audio Input on the Digital Preampifier.

Note: An Optical or Coaxial Cable Connection may be used instead of the Digital XLR Connection.

AC Power Cords Connections:

7. Connect the McIntosh MCT500 SACD/CD Transport AC Power Cord to a live AC outlet.

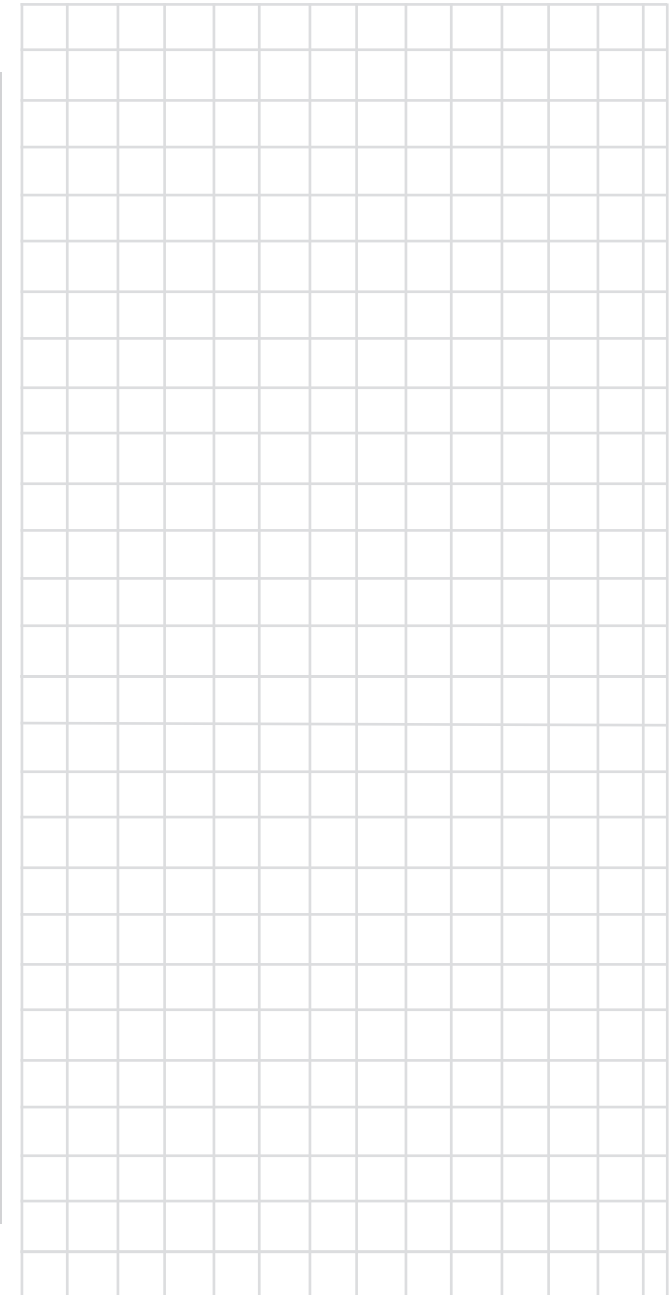

Select between Disc Playback or USB Playback

USB Drive Input Connector for USB Flash Memory Drives

Disc Tray opens to load and unload a disc

IR Sensor receives commands from a Remote Control

Standby Power On Indicator and the color indicates the status of the Auto Off Feature

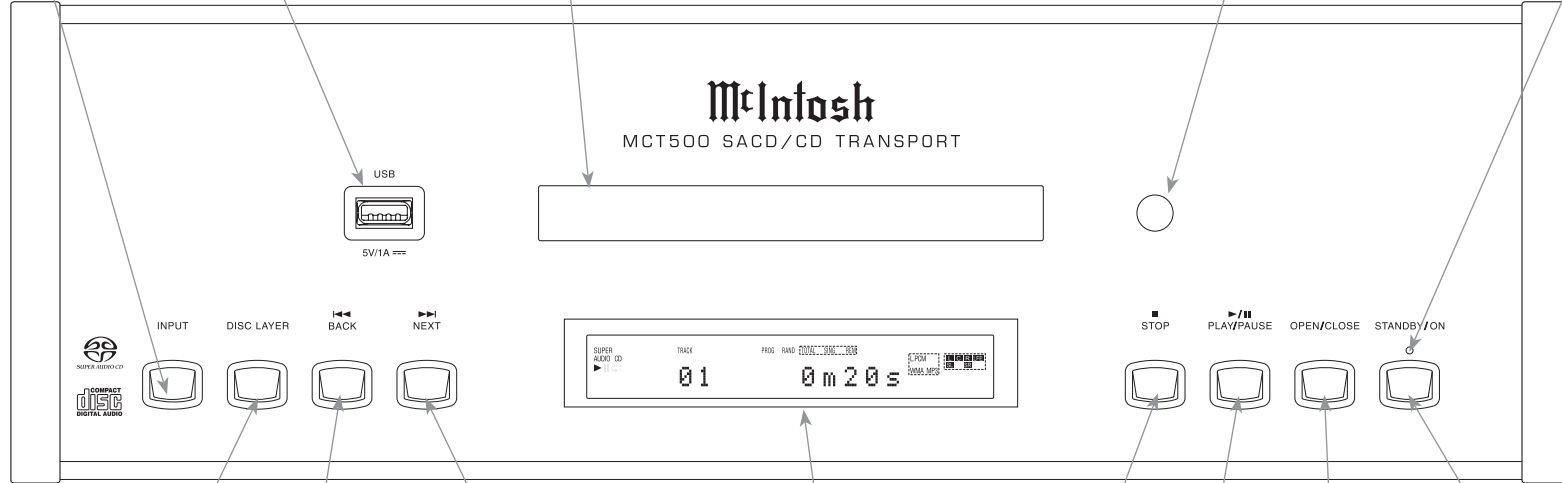

Selects the SACD or CD Audio Tracks from a hybrid disc

Move forward one track at a time

Move backward one track at a time

Front Panel Display indicates various operation functions and times

STOPS disc playback

Starts disc PLAYback and PAUSEs disc playback

OPENS and CLOSEs the disc tray for loading or unloading discs

STANDBY/ON Push-button switches the MCT500 ON or OFF (Standby)

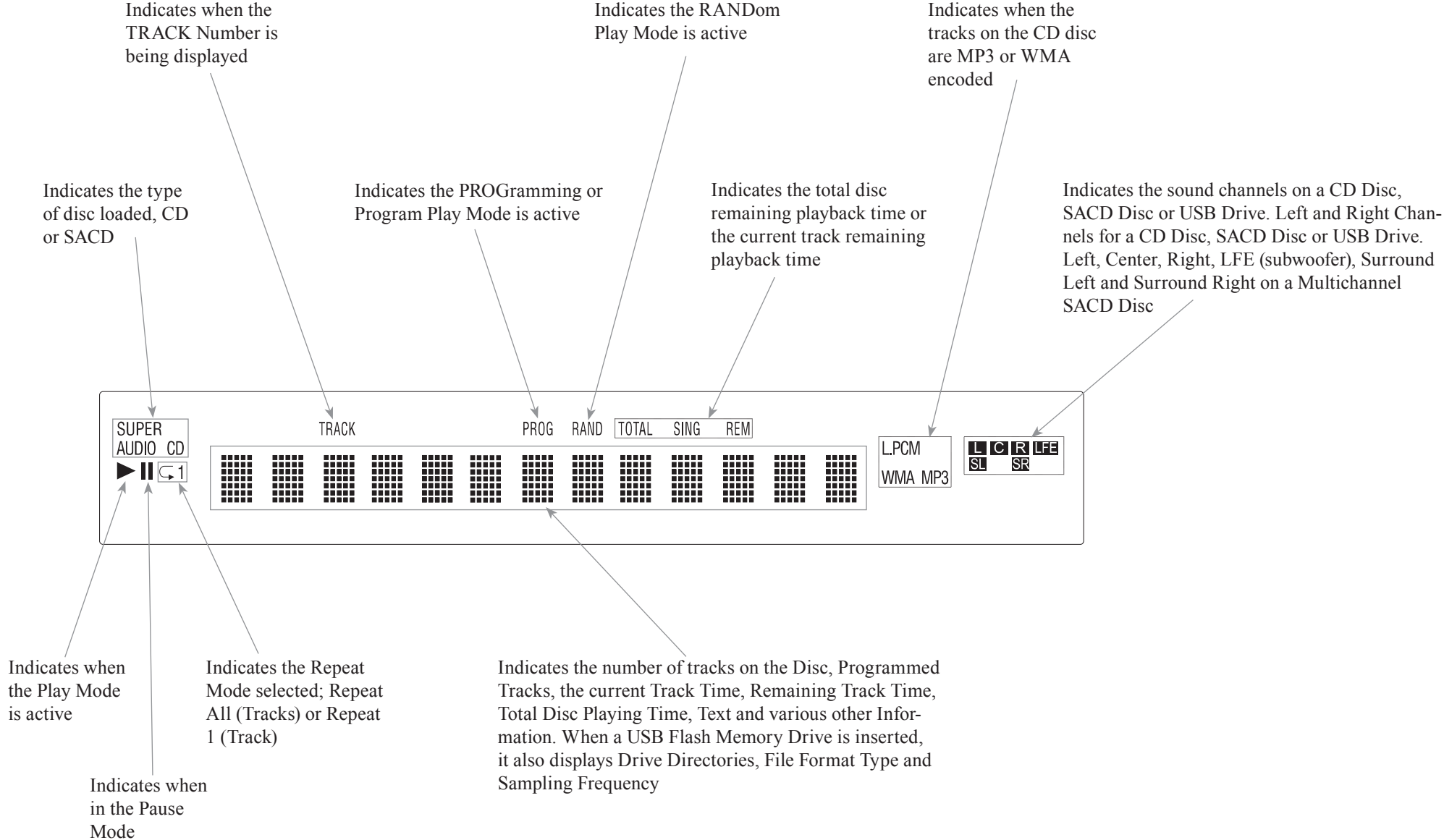



Remote Control Push-Buttons for CD Disc and SACD Disc Playback

SHIFT push-button with LED Indicators used to select a push-button function with white or gold color nomenclature

Use to CLEAR the last programmed track

Access the TEXT Display Mode when playing a SACD Disc containing the information

Use to select various disc information, including TIME, on the Front Panel DISPLAY. It is also used to cancel the text display mode on a SACD Disc

Use to select the SACD or CD Tracks from a hybrid disc for playback

Press to play the Previous Selection. Also used to select one of various REPEAT modes

Press once to PLAY, a second time to PAUSE and a third time to RESUME playback. Also used to activate RANDOM playback of the tracks on a SACD or CD disc

Press to FAST-REVERSE thru the current selection

Momentarily press to Power ON or OFF

Use to select disc tracks or any numbered operation

Use to direct access tracks 10 and above

Selects the All MODE or the Folder MODE for navigating and selection of music on a CD-R or DVD ±R and Flash Drive

LEVEL Control adjusts the volume level for the Rear Panel Variable Audio Output Connectors and the Front Panel Headphone Jack

Press to play the next Selection

Press to FAST-FORWARD thru the current selection

Select Disc, USB Mode or Coax/Optical Digital Inputs

Press to STOP disc playback

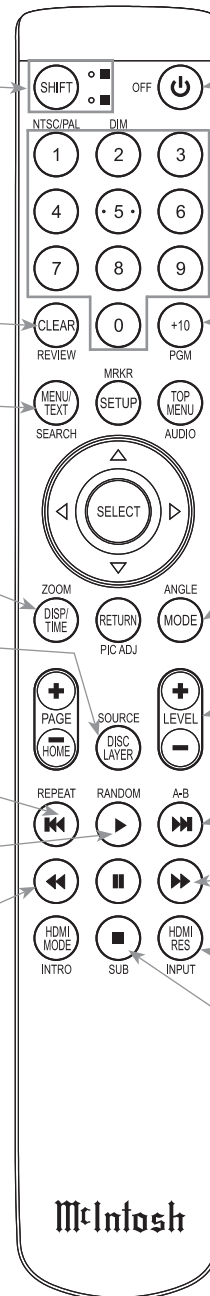

Note: The Remote Control Push-buttons not identified are for use with other McIntosh Products

How to use the Remote Control for CD Disc and SACD Disc Playback

The Remote Control is capable of performing most Operating Functions for the MCT500 SACD/CD Transport.

If at any time the Player seems unresponsive to the desired Remote Control Command, it may be necessary to select the color of the push-button nomenclature for the desired command. This is accomplished by first pressing the SHIFT Push-button to select gold, as indicated by the LED, and then within 3 seconds pressing (or in the case of some functions repeatedly pressing) the desired command push-button.

Note: Refer to the "How to Operate" Section of this manual for additional information using this Remote Control.

Play and Pause

With a disc loaded, press the PLAY ► Push-button to start the disc playing. Press the PLAY ► Push-button a second time to temporarily stop disc playback at any time (Pause). To resume playback press the PLAY ► Push-button again.

Note: The Play and Pause functions have been combined into the Play Push-button.

Stop

Press the STOP ■ Push-button to stop disc playback and return to displaying the table of contents of the disc.

Numbered Push-buttons

Press 1 through 9 to directly access one of the first nine Disc Tracks using the Front Panel Information Display. For track numbers greater than 10, press the +10 Push-button followed by the 0-9 Push-button. For example, to access Disc Track 23, press the +10 Push-button twice and then the 3 Push-button.

Reverse and Fast Forward

Press the ◀◀ (Reverse) or ▶▶ (Fast Forward) Push-button to start moving rapidly through a track on the disc. When the desired location is reached release the ◀◀ (Reverse) or ▶▶ (Fast Forward) Push-button to resume normal playback.

Back and Next

Press the ▶▶ (Next) Push-button to move forward one track or the ◀◀ (Back) Push-button to move back to the beginning of the current track playing. Also used to review the Programmed Tracks from the disc on the Front Panel Information Display, while in the Program Mode.

Note: If the ◀◀ (Back) Push-button is pressed during playback of the first three seconds of the track, the SACD/CD will start playing back the previous track from the beginning. If the Front Panel Information Display is indicating time, the display will momentarily indicate the track number.

SACD or CD Track Selection

Press the DISC LAYER Push-button to select the SACD or CD Tracks from a hybrid disc for playback.

Display/Time

Press the DISPlay/TIME Push-button to access various disc times. It is also used to return the Front Panel Information Display to indicating time instead of text information on a SACD Disc.

Menu/Text

Press the MENU/TEXT Push-button to select the various text information on a SACD Disc such as Album, Artist and Track Titles (disc dependent).

Repeat Modes

Press the REPEAT Push-button to select either One Track, All Tracks or cancel the Repeat Mode.

Clear

Press the CLEAR Push-button to erase a program track(s).



Remote Control Push-Buttons for Playback of Data CD, Data DVD Disc and USB Flash Memory Data Drive

SHIFT push-button with LED Indicators used to select a push-button function with white or gold color nomenclature

Refer to page 22 for information on the use of Push-buttons 2, 4, 5, 6 and 8 for playback of Data CD, Data DVD Disc and USB Flash Memory Data Drive

Access the TEXT Display Mode when playing back a music track

Refer to page 22 for information on the use of DISPLAY/TIME Push-button for playback of Data CD, Data DVD Disc and USB Flash Memory Data Drive

Press Back to play the Previous Selection. Also used to select one of various repeat modes

Press once to PLAY, a second time to PAUSE and a third time to RESUME playback. Also used to activate random playback of the tracks

Press to FAST-REVERSE thru the current selection

Momentarily press to Power ON or OFF

Selects the ALL or FOLDER Operational Modes for playback of Data Disc (CD or DVD) or DATA USB Flash Drive

LEVEL Control adjusts the volume level for the Rear Panel Variable Audio Output Connectors and the Front Panel Headphone Jack

Press to play the NEXT Selection

Press to FAST-FORWARD thru the current selection

Select Disc, USB Mode or Coax/Optical Digital Inputs

Press to STOP playback

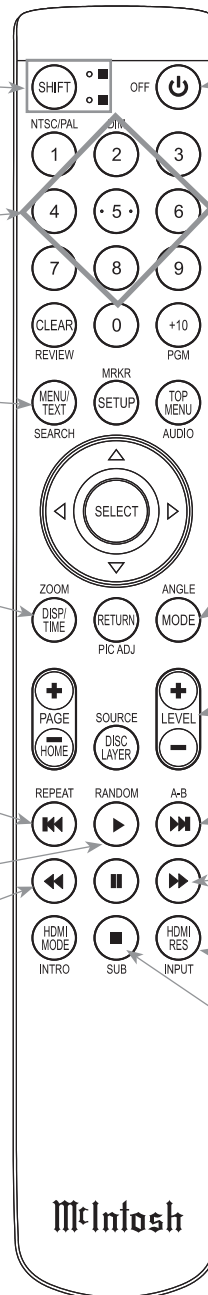

Note: The Remote Control Push-buttons not identified are for use when playing back CD/SACD Discs (refer to page 14) or for use with other McIntosh Products

How to use the Remote Control for Playback of Data CD Disc, Data DVD Disc and USB Flash Memory Data Drive

The Remote Control is capable of performing most Operating Functions for Data Disc and the USB Flash Memory on the MCT500.

If at any time the Player seems unresponsive to the desired Remote Control Command, it may be necessary to select the color of the push-button nomenclature for the desired command. This is accomplished by first pressing the SHIFT Push-button to select gold, as indicated by the LED, and then within 3 seconds pressing (or in the case of some functions repeatedly pressing) the desired command push-button.

Note: Refer to the "How to Operate" Section of this manual for additional information using this Remote Control.

Remote Control Button Functions

When playing a Data CD Disc, Data DVD Disc or USB Flash Memory Drive, some of the Remote Control Push-buttons that are labeled for stand CD and SACD Operation Functions will also perform different additional Operation Functions.

Playback Operation Mode

The MCD600 has different Operational Playback Modes when a Disc or USB Flash Drive contains DATA MUSIC FILES. The Operational Mode Selection includes the "All Mode" and the "Folder Mode" which are indicated by the Front Panel Display, refer to figures A and B.

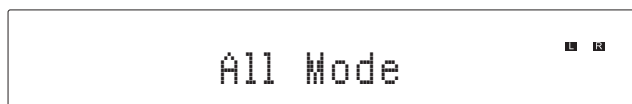

Figure A

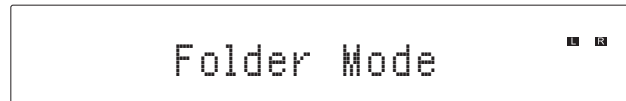

Figure B

To check the current Operation Mode press the MODE Push-Button on the Remote Control once. To change the current Operation Mode, press the MODE Push-Button on the Remote Control twice, followed by pressing the PLAY▶ Push-button on the Remote Control to activate the selected Operation Mode.

When conventional CD or SACD DISCS are played, all the sound tracks are sequentially numbered and are played back in that numeric order. This standard playback mode is referred to as the "All Mode" of operation.

CD Data, DVD Data and USB Flash Drive containing DATA sound tracks are usually created on a computer which can create multiple Folders that are in a sequential order. Each folder can contain multiple sound tracks that are in a sequential order. This playback mode is referred to as the "Folder Mode" of operation. Refer to "Front Panel Display" for sample Front Panel Indications of the Folder Mode content.

For additional information on the playback of CD Data, DVD Data and USB Flash Drive containing DATA sound tracks in the Folder Mode of Operation, refer to pages 21 -22.

Front Panel Display

When playing a Data CD Disc, Data DVD Disc or USB Flash Memory Drive containing DATA MUSIC FILES, the MCD600 Front Panel Information Display will also indicate the following:

- Folder or Sub-Folder Name - Music One
- Artist Name - Freddie King
- Album Name - Getting Ready
- Track Name - 09 Tore Down
- Audio Format Type and Sampling Frequency - WAV 44.1kHz
- Upper and Lower Symbol

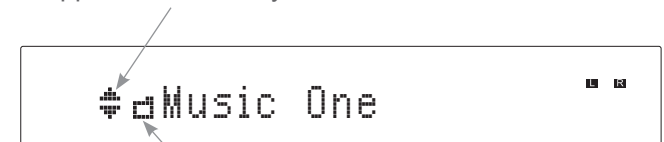

Folder Symbol



Music Symbol

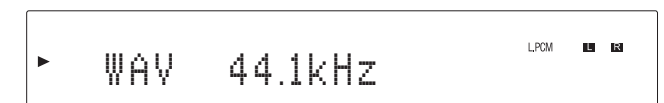
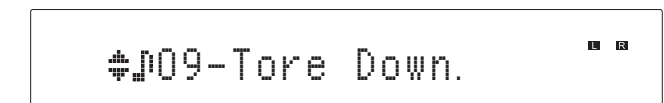
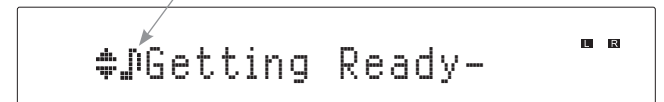



How to Operate the MCT500

Power On and Off

The LED above the STANDBY/ON Push-button lights to indicate the MCT500 is connected to AC Power. Refer to figure 1. The LED also indicates the status of the Auto Off Feature. When the MCT500 is in the Standby Mode, green illumination indicates the Auto Off Feature is enabled (default setting) and red illumination indicates the Auto Off Feature is disabled. For additional information refer to “Power Mode” on page 23.

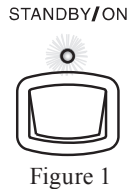



Figure 1

Note: When AC Power is initially applied to the MCT500, the unit will momentarily switch On and then go into the Standby Mode.

To Switch ON the MCT500, momentarily press the STANDBY/ON Push-button on the Front Panel or the  (Power) Push-button on the Remote Control. Refer to figures 2 and 21. The LED above the STANDBY/ON Push-button illuminates green. The Front Panel Display will momentarily indicate “DISC” followed by “READING” and then “NO DISC”. Refer to figures 2, 3, 4, 5 and 21. To switch OFF the MCT500, momentarily press the STANDBY/ON Push-button on the Front Panel or the OFF Push-button on the Remote Control.

DISC READING NO DISC

Figure 3

Figure 4

Figure 5

How to Load and Unload a Disc

1. Press the OPEN/CLOSE Push-button. The disc tray will slide out allowing a CD Disc to be loaded. Refer to figure 6.
2. Press the OPEN/CLOSE Push-button and the disc tray will close. Refer to figure 7. Loading of the CD Disc’s Table of Contents (number of tracks and total playing time) will be indicated on the Front Panel Display. Refer to figure 8.

OPEN

Figure 6

CLOSE

Figure 7

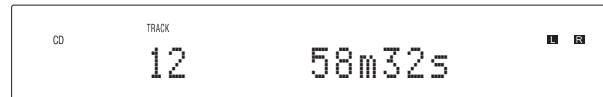

Figure 8

- Notes:*
1. The MCT500 will start up selecting the same source it played last.
 2. When a Disc is placed in the tray and the PLAY/PAUSE Push-button is pressed, the tray will close and the first track will start playing.
 3. If a USB Flash Memory Data Drive was inserted into the USB Front Panel Socket,

the INPUT Push-button needs to select “DISC” after AC Power is switched ON to the MCT500.

3. Pressing the OPEN/CLOSE Push-button will stop playback of the disc and the disc tray will open.

How to Play a SACD Disc

Load a SACD Disc into the MCT500. The Front Panel Display will first scroll the Album Title of the SACD Disc (available on most SACD Discs). Refer to figures 9, 10 and 11.



Figure 9

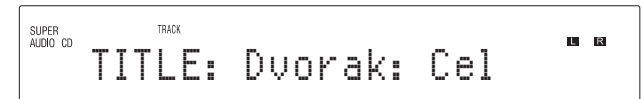

Figure 10



Figure 11

The Album Title is followed by the Table of Contents. Refer to figure 12.

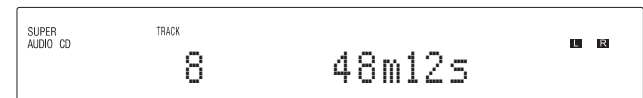



Figure 12

Press the PLAY/PAUSE  Push-button on the Front Panel of the MCT500 or on the Remote Control. Refer to figures 2 and 21. The Disc will start playing the first track of the SACD Layer.

Note: The default setting for SACD/CD Hybrid Disc is to play the SACD Stereo Layer. The default setting may be changed to play the CD Layer or the SACD Multichannel Layer, when available. With the MCT500 On and no disc loaded,

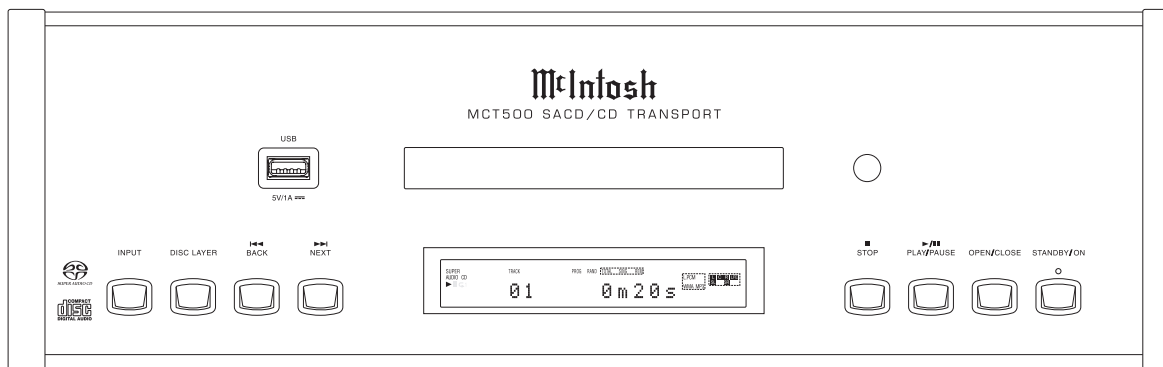

Figure 2

press the DISC LAYER Push-button until the Front Panel Display indicates the desired layer.

Selection of a different Layer (CD, Stereo or Multichannel) can occur during playback of a disc by pressing the DISC LAYER Push-button once to see the current selection and a second or third time to select the desired Layer. Refer to figures 13, 14 and 15. The Player will stop playing the current Layer and then load the desired Layers' Table of Contents (Number of tracks and Total Playing Time). Once the information is indicated on the front panel display, press the PLAY/PAUSE ►/ || Push-button. Refer to figure 16.

STEREO

Figure 13

MULTI

Figure 14

CD

Figure 15

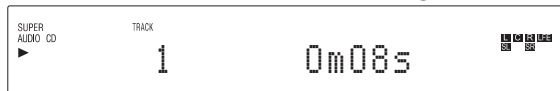

Figure 16

Note: 1. Most SACD Disc(s) have the ability of displaying the Album Title and Artist. With the disc loaded, SACD Table of Contents read and the disc stopped, press the MENU/TEXT Push-button once for scrolling the Title and twice for scrolling the Artist Name. Display of the Artist information is not available during playback of the disc. Refer to figures 17, 18 and 21.



Figure 17

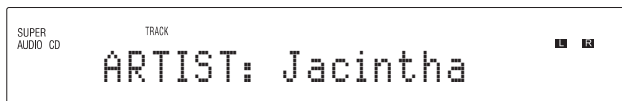

Figure 18

2. In a similar manner, some SACD Discs have the ability of scrolling the Track Number and Title by pressing the MENU/TEXT Push-button **after** the Track has started to play. Refer to figures 19 and 21.

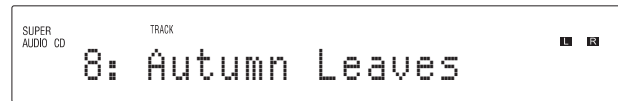

Figure 19

3. The Text Display Mode may be canceled by pressing the DISP/TIME Push-button on the Remote Control. Refer to figure 21.
4. The various Time Modes may be displayed by pressing the DISP/TIME Push-button on the Remote Control. Refer to figure 21. For additional information on the Time Display Modes refer to "Display Modes" on page 20.
5. SACD Discs containing Multichannel sound will not produce output when this layer is selected because the MCT500 is a two channel (stereo) unit.

How to Play a CD Disc

With a disc already loaded into the MCT500, press the PLAY/PAUSE ►/ || Push-button on the Front Panel of the MCT500 or Remote Control. Refer to figures 2, 20 and 21.

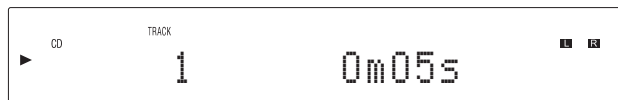

Figure 20

How to Pause a Disc

This feature allows for the temporary stopping of disc playback. Refer to figures 2 and 16.

1. When playing a Disc, press the PLAY/PAUSE ►/ || Push-button to temporarily stop playback.
2. Press the PLAY/PAUSE ►/ || Push-button to resume playing the disc.

Track Back

Return to the beginning of the Track currently playing by momentarily pressing the MCT500 Front Panel BACK ◀◀ Pushbutton or the ◀◀ Push-button on the Remote Control. Press and hold the ◀◀ Push-button for rapid selection of the desired previous Track. Refer to figures 2 and 21.

Track Next

Advance to the next Track by momentarily pressing the MCT500 Front Panel NEXT ▶▶ Push-button or the ▶▶ Push-button on the Remote Control. Press and hold the ▶▶ Push-button for rapid selection of the desired next Track. Refer to figures 2 and 21.

Fast Forward or Reverse

Using the Remote Control, press the ▶▶ (Fast Forward) or ◀◀ (Reverse) Push-button to search back and forth rapidly through a Track on a disc. To return to normal playback, release the same ▶▶ (Fast Forward) or ◀◀ (Reverse) Push-button. Refer to figure 21.

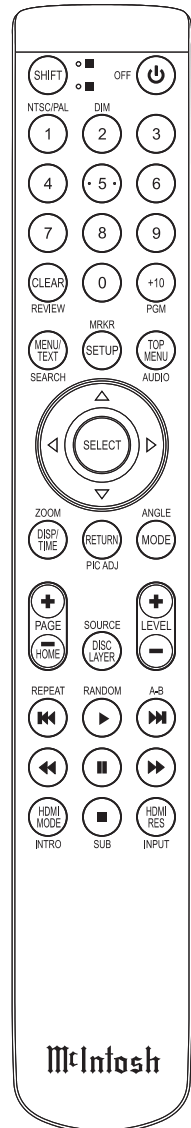

Figure 21



How to Operate the MCT500, con't

Stop Mode

Press the STOP ■ Push-button at any time to stop Playback. To listen to the disc again, press the PLAY/PAUSE ►/|| Push-button and playback will start from the beginning of the disc.

Direct Track Selection

The MCT500 Front Panel Display indicates the Disc Track currently playing. Use the Remote Control NUMERIC Push-button(s) to enter the desired Track Number. Refer to pages 14 and 15 for additional information using the Remote Control.

Repeat

This allows repeating a Track, Disc, Program Mode or Random Play Mode on a continuous basis. Refer to figures 2 and 24.

1. With the disc playing (Regular, Program or Random Playback Modes), press the SHIFT Push-button then the REPEAT Push-button once to activate the Track Repeat (C1); press the REPEAT Push-button twice to activate the Disc Repeat (C). Refer to figures 22 and 23.



Figure 22



Figure 23

2. To cancel the previously selected Repeat Mode, press the REPEAT Push-button until the character "1" and/or the symbol "C" in the Front Panel Information Display is extinguished.

Random Playback

This feature allows for listening to Tracks of a Disc in a Random Order. Refer to figure 24.

Note: Before the Random Playback Mode feature on the MCT500 can be activated, the disc must be stopped or the message "Press ■ (stop) first" will momentarily appear on the Front Panel Display. Refer to figure 25.

1. With the MCT500 in the STOP ■ Mode press the SHIFT Push-button and then the RANDOM

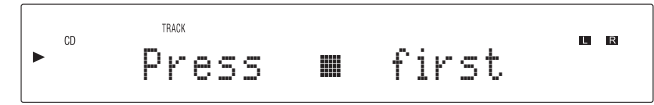

Figure 25

Push-button. The word RANDOM will be indicated in the Front Panel Display. Refer to figure 26.

2. Press the PLAY/PAUSE ►/|| Push-button to start Random Playback. After all the tracks have been played the MCT500 will stop.

Notes: 1. To provide continuous playback of the disc, press the REPEAT Push-button twice to activate the Disc Repeat (C) after the Random Playback Mode has started. If Repeat (C1) is selected, the current track will repeat.

2. The NEXT TRACK ►► function will advance to the next random selection and start playing.

3. To cancel the Random Playback Mode, press the STOP ■ Push-button, then press the RANDOM Push-button twice.

Program Playback

This feature allows for playback of selected Tracks on a Disc in the desired order. In the following example, a Disc is programmed to play Track 6 followed by Track 4 and then Track 2.

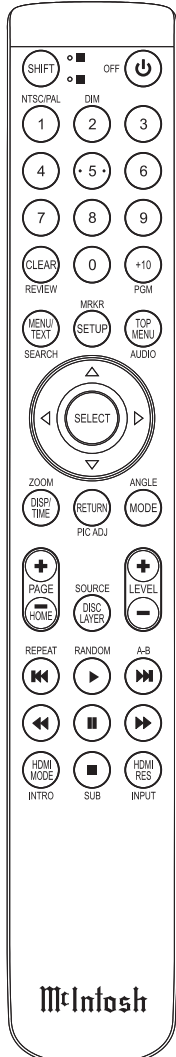

Figure 24

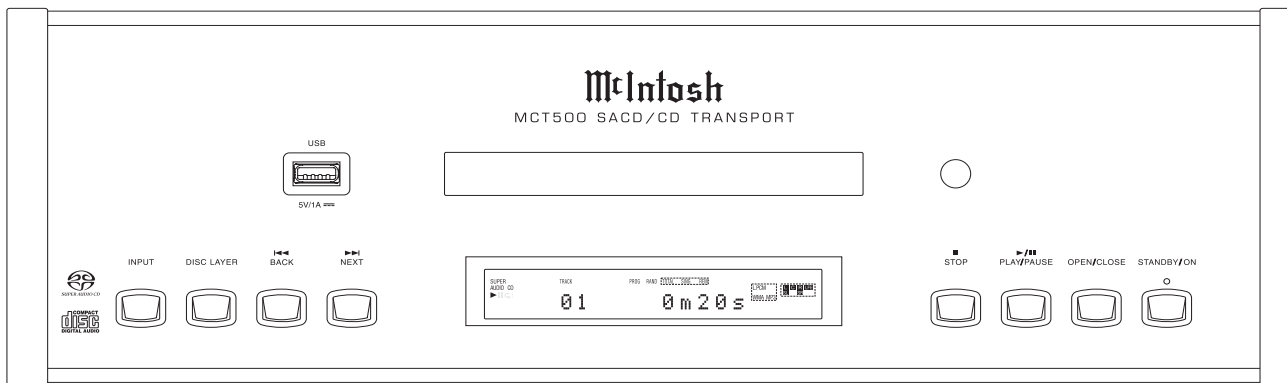

Figure 2



Figure 26

Notes: 1. The MCT500 must be in STOP Mode with the Disc TOC (Table of Contents) read before the Program Playback Mode Feature can be activated.

2. When programming Hybrid SACD Discs, first choose the layer (SACD or CD) so the correct TOC can be read, as some discs have different selections for the SACD and CD Tracks.

1. Press the SHIFT Push-button and then the RANDOM Push-button twice to access the Program Mode. Refer to figures 2, 24 and 27.

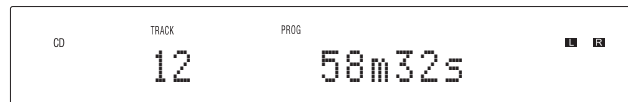

Figure 27

2. Enter the first desired selection (track 6) using the Numeric Push-buttons. The Front Panel Display will first indicate track 6 followed by indicating the total number of tracks and total playback time for the current program. Refer to figures 28 and 29.



Figure 28



Figure 29

3. In a similar manner, enter the remaining Tracks 4 and 2. Refer to figures 30 thru 33.

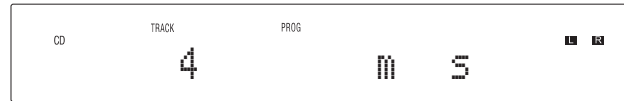

Figure 30



Figure 31



Figure 32

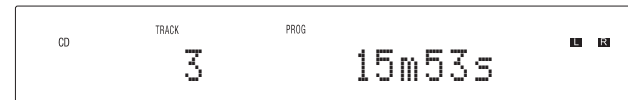

Figure 33

Note: To view and/or delete the selections programmed, use the TRACK NEXT $\blacktriangleright\blacktriangleright$ Push-button to step through programmed tracks and the CLEAR Push-button to remove any unwanted selections.

4. To start playback of the just entered program, press the PLAY/PAUSE $\blacktriangleright/\parallel$ Push-button. Refer to figure 34.



Figure 34

After playback begins, the Repeat Mode can be activated to provide continuous playback of the Programmed Track(s). Refer to figure 24.

Note: To momentarily stop playback, press the PLAY/PAUSE $\blacktriangleright/\parallel$ Push-button. To resume Program Playback press the PLAY/PAUSE $\blacktriangleright/\parallel$ Push-button.

5. To cancel the Program Playback Mode, press the STOP \blacksquare Push-button, then the SHIFT Push-button and then the RANDOM Push-button.

Once the Program Playback Mode is active, tracks may be added or deleted by first pressing the STOP \blacksquare Push-button followed by entering the additional tracks using the Numeric Push-buttons or delete the last track programmed by using the CLEAR Push-button.

MP3/WMA Disc Playback

The MCT500 has the ability of playing back MP3 and WMA encoded discs. MP3 and some version of WMA coding allow more tracks on the Disc by using the technique of lossy compression applied to the original audio information. These Tracks have lower audio quality than the original recording. Load a MP3/WMA disc into the MCT500. Refer to figure 36.



Figure 36

The MCT500 has two MP3/WMA Modes of Operation: Disc Mode and Folder Mode. Refer to figures 37 and 38. Select the desired mode by pressing the



Figure 37

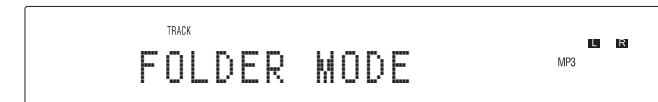

Figure 38

MODE Push-button on the Remote Control. The Disc Mode will playback all the tracks on the disc starting with tracks not in folders, followed by the



How to Operate the MCT500, con't

tracks contained in the folder. The Folder Mode will play back the tracks contained in the selected folder. Refer to figure 39.



Figure 39

1. Press the PLAY/PAUSE ►/ || Push-button to start Playback. Refer to figure 40.

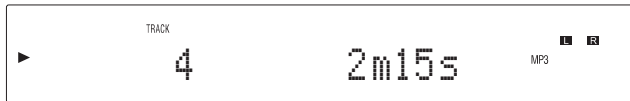

Figure 40

After all the tracks have been played the MCT500 will stop.

Note: Use the ▲ up and ▼ down directional Push-buttons to select folders on the disc.

Playback of Data Disc or USB Flash Memory Data Drive

Load a DATA Disc (CD or DVD) or insert a DATA USB Flash Memory into the MCT500. The Front Panel Display will then indicate whether a Data Disk or a DATA USB Flash Memory has been inserted into the MCT500. For additional information refer to pages 16 and 17.

After the Folder Mode has been selected, the Front Panel Information Display will indicate the Folders, Sub Folders and Tracks. It also indicates the Album Name, the Artist Name, the Track Name, the Track Time, along with the Audio Format Type and Sampling Frequency. Due to the operational differences

of various computers and the MCT500, sequel listing of the Folders, Sub Folders and Tracks will usually be different. If the All Mode on the MCT500 was selected the sequential listing will also be different.

Starting Playback

1. Use the INPUT Push-button to select USB or DISC.
2. Using the Remote Control, press the Number 5 Push-button to start playback.
3. If the desired track for playback is located in a different folder, first press the Number 4 Push-Button. Then use the Number 2 (select the Upper▲ Data Folder) or Number 8 (select the Lower▼ Data Folder) Push-Button to select the desired Folder. Select the desired Track using the Number 2 or Number 8 Push-button. Once the Desired Track Name is indicated on the Front Panel Information Display, press the Number 5 Push-button to start playback of the track.

Note: Once the desired folder has been selected the Remote Control NEXT ►► Push-button can be used to select the desired track. Then the Remote Control PLAY ► Push-button when pushed will start playback of the track.

4. While the track just selected is playing back, the Front Panel Display may also indicate the Track Name, followed by the Artist Name and/or the Album Name by pressing the MENU/TEXT Push-button several times.
5. Press the DISPLAY/TIME Push-button (once or twice) to indicate on the Front Panel Display, the Audio Format Type and Sampling Frequency of the track that is playing back.

Selection of a Different Sub Folder

1. Press the Number 4 Push-button. The Front Panel Display will indicate the name of the current Folder.
2. Press the Number 2 Push-Button to select an Upper▲ Data Folder or press the Number 8 Push-Button to select a Lower▼ Data Folder. Once the desired folder has been selected, push the Number 6 Push-Button once to indentify the first track in the folder. Press the Number 6 to start playing the first track from the selected folder or press the Number 6 a second time to start playing the second track.
3. Press the MENU/TEXT Push-button to display the Artist Name, followed by the Album Name and then the Track Name and Number.
4. Press the DISP/TIME Push-button to display the track number display time. Press the DISP/TIME Push-button a second time to display the Audio Format Type and the Sampling Frequency.

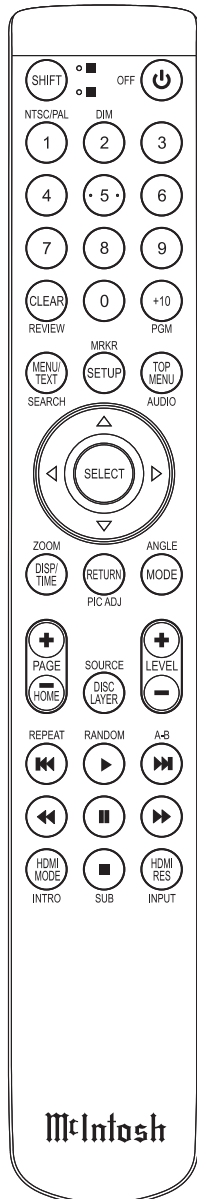

Figure 24

Display Modes

The MCT500 Front Panel Display indicates both track number and playing time. There are three playing time display indications: track elapse time, track remaining time or disc remaining time. To change from the default setting of track elapse time, press the DSP/TIME Push-button on the Remote Control. Refer to figures 24, 41, 42 and 43.

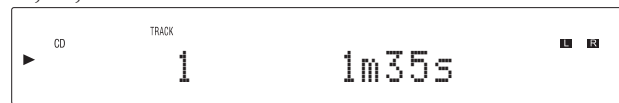

Figure 41

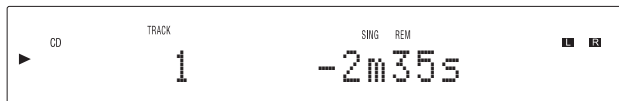

Figure 42



Figure 43

Display Brightness

There are three available Settings for the Front Panel Display. The choices include brightness settings of high (default setting), medium or low. To change the brightness setting perform the following steps and refer to figure 24:

1. Press the SHIFT Push-button.
2. Momentarily press the 2 (DIM) Push-button to change the current brightness setting. Repeat this until the desired brightness setting is selected.
3. Press the DISC LAYER Push-button to store the new brightness setting.

Power Mode

The MCT500 incorporates an Auto Off Feature, which can automatically place the SACD/CD Transport into the Power Saving Standby/Off Mode (default setting). This occurs approximately 30 minutes after there has been an absence of a Digital Audio Signal. If it is desirable to disable the Auto Off Feature, perform the following steps:



1. Using the MCT500 Remote Control, press and hold in the  (Power) Push-button for about 5-10 seconds, at which time the Front Panel Display indicates "Auto STBY Off". Refer to figure 44.



Figure 44

2. The MCT500 will switch Off and the LED above the STAND/BY Push-button will illuminate Red in color. Press the  (Power) Push-button to switch the MCT500 On.
3. To re-activate the Auto Off Feature, press and hold in the  Power Push-button on the Remote Control for about 5-10 seconds, at which time the Front Panel Display indicates "Auto STBY On". Refer to figure 45.

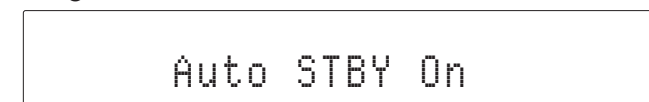



Figure 45

4. The MCT500 will switch Off and the LED above the STAND/BY Push-button will illuminate Green in color. Press the  (Power) Push-button to switch the MCT500 On.



Resetting the MCT500

FIRST PROCEDURE

In the unlikely event the MCT500 stops functioning, first try resetting the Main (System) Microprocessor by performing the following:

1. Switch Off the MCT500 by using the STANDBY/ON Front Panel Push-button. Then simultaneously press and hold in the Front Panel STANDBY/ON and DISC LAYER Push-button until the illumination of the LED above the STANDBY/ON Push-button goes Off.
2. Press the STAND/BY Push-button to switch the MCT500 back On.

Notes: 1. Resetting of the microprocessor also places the Power Saving Mode into the default setting of On.

2. If the MCT500 is not performing normally, perform the second procedure below.

SECOND PROCEDURE

If the MCT500 is still not functioning properly, reset the Secondary (Transport) microprocessor by performing the following:

1. Switch Off A.C. Power going to the MCT500.

Note: Temporarily, connect the AC Power Cord coming from the MCT500 into an AC Power Strip with an On/Off Switch. Position the AC Power Strip so the On/Off Switch on the strip is in very close proximity to the MCT500 Front Panel NEXT and STOP Push-buttons (the MCT500 Remote Control STOP Push-button will not work for resetting the micro).

2. Press and hold in the NEXT▶▶ and STOP■ Push-buttons while at the same time switching On the AC Power Strip.
3. The Front Panel Display will indicate “INITIALIZED” then release the NEXT▶▶ and the STOP■ Push-button.
4. When the Front Panel Display indicates “DISC” or “NO DISC”, press the STANDBY/ON Push-button to switch the MCT500 OFF. Now reconnect the MCT500 AC Power Cord the way it was connected before performing Step 1 *Note*, then switch the MCT500 back On.

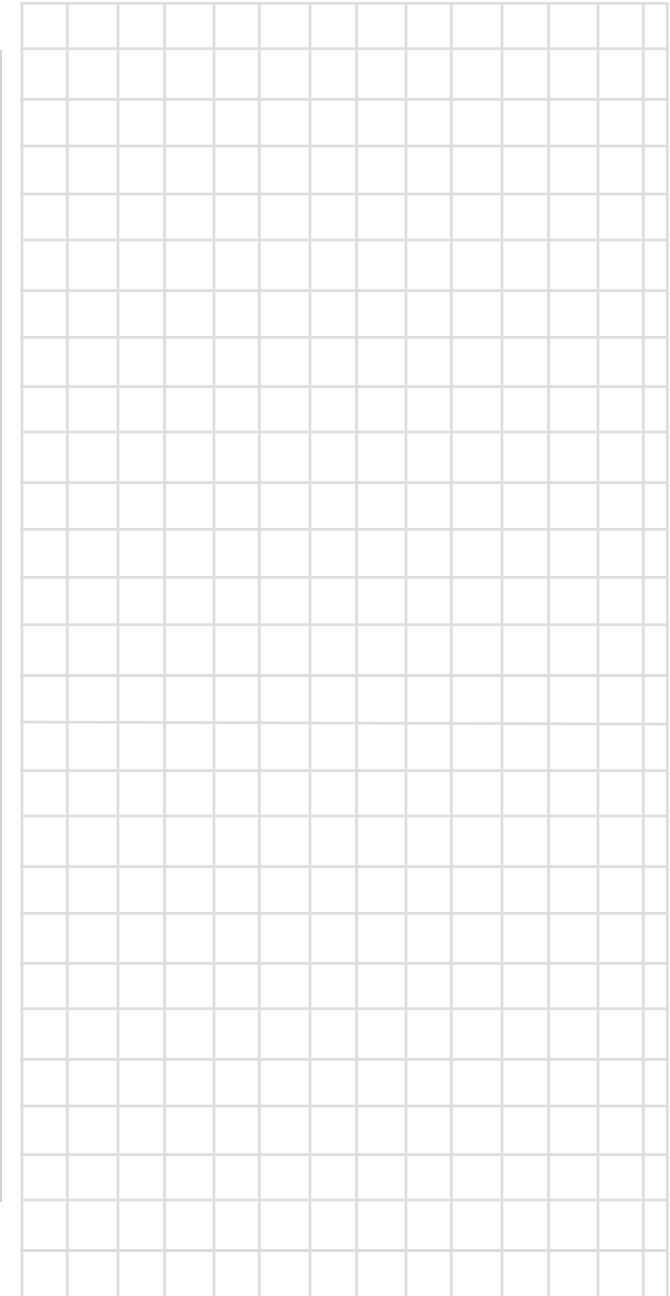





Digital Audio Specifications

Digital Audio Output Format

Coaxial and Optical: SPDIF (PCM¹), IEC958
44.1kHz to 192KHz/24Bit
Digital MCT: SPDIF (PCM²), IEC958
44.1kHz to 96KHz/24-Bit
SACD DSD
Data DVD up to DSD128

Digital Audio Outputs

Coaxial: 0.5V p-p/75 ohms
Optical: - 15dbm to -21dbm (TOS Link)
XLR(AES/EBU): 0.5V p-p/150 ohms
Digital MCT: 3V @110 ohms

¹ PCM (Pulse Code Modulation) Digital Signal type used for CD Discs

² DSD (Direct Stream Digital) Digital Signal type used for SACD Discs

General Specifications

Transport

Laser Type: Twin Beam
Laser Beam Wavelength: 650nm (SACD)/790nm (CD)
Laser Power: CLASS IIa/CLASS I

Power Requirements

100 Volts, 50/60Hz at 35 watts
110 Volts, 50/60Hz at 35 watts
120 Volts, 50/60Hz at 35 watts
127 Volts, 50/60Hz at 35 watts
220 Volts, 50/60Hz at 35 watts
230 Volts, 50/60Hz at 35 watts
240 Volts, 50/60Hz at 35 watts
Standby: Less than 0.5 watt

Note: Refer to the rear panel of the MCT500 for the correct voltage.

Overall Dimensions

Width is 17-1/2 inches (44.4cm)
Height is 6 inches (15.2cm)
Depth is 19 inches (48.3cm) including the Front Panel and Cables

Note: When the Disc Tray is opened, the panel clearance required in front of mounting panel is 6-3/4 inches (17.2cm).

Weight

26 pounds (11.8Kg) net, 40.5 pounds (18.4Kg) in shipping carton

Shipping Carton Dimensions

Width is 26-1/2 inches (67.3cm)
Depth is 24-1/4 inches (62.2cm)
Height is 11-3/4 inches (29.9cm)

Packing Instructions

In the event it is necessary to repack the equipment for shipment, the equipment must be packed exactly as shown below. It is very important that the four plastic feet are attached to the bottom of the equipment. This will ensure the proper equipment location on the bottom pad. Failure to do this will result in shipping damage.

Use the original shipping carton and interior parts only if they are all in good serviceable condition. If a shipping carton or any of the interior part(s) are needed, please call or write Customer Service Department of McIntosh Laboratory. Refer to page 4. Please see the Part List for the correct part numbers.

Quantity	Part Number	Description
1	033838	Shipping carton only
4	033837	End cap
1	033836	Inside carton only
1	033725	Top pad
1	034576	Bottom pad
2	034446	Foam plug
4	017937	Plastic foot
4	400159	#10-32 x 3/4" screw
4	404080	#10 Flat washer

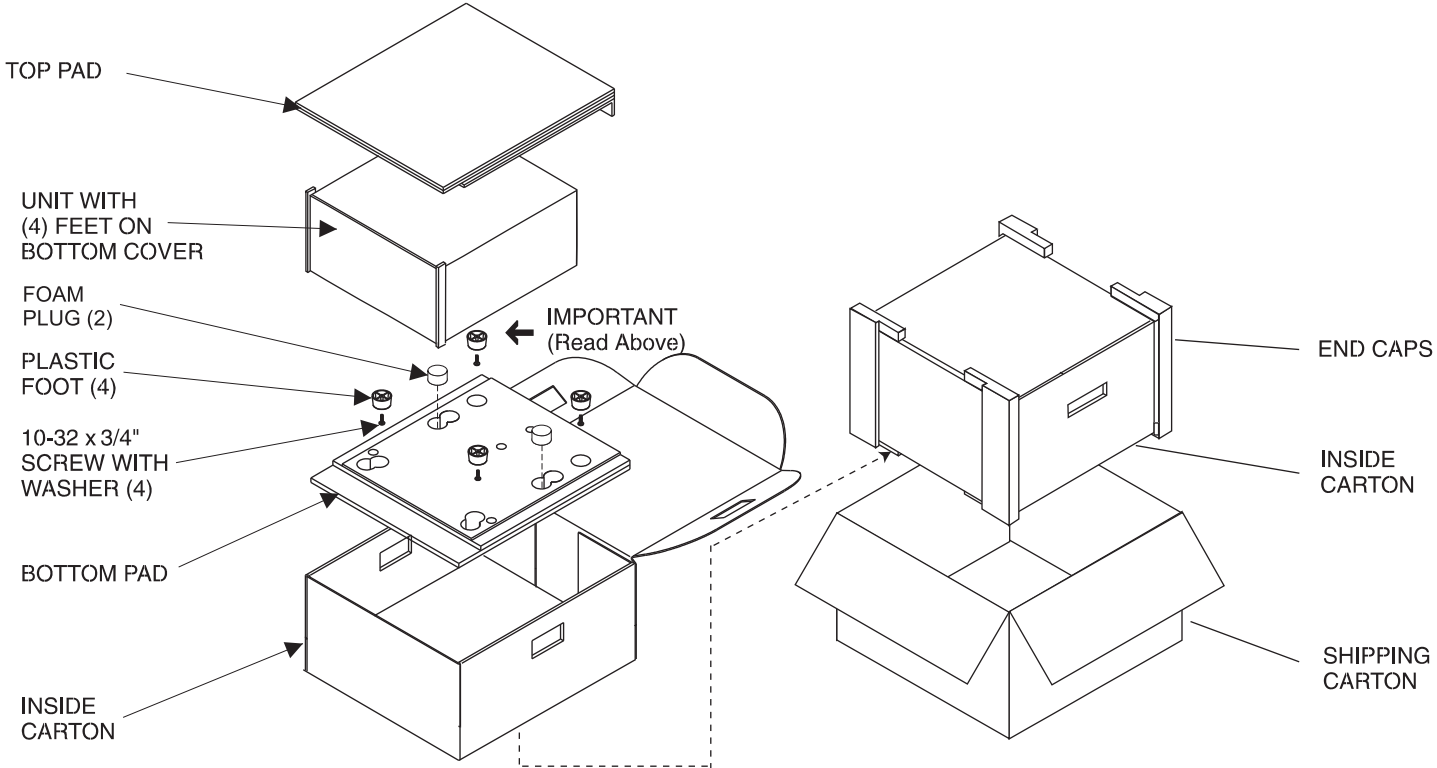



McIntosh Laboratory, Inc.
2 Chambers Street
Binghamton, NY 13903
www.mcintoshlabs.com

The continuous improvement of its products is the policy of McIntosh Laboratory Incorporated who reserve the right to improve design without notice.
Printed in the U.S.A.